

A.T.X.[®] PRE Series 16 Amp Plugs and Sockets**Increased Safety**

ATEX/IECEX:
Zone 1 and 2 - 21 and 22
 Ⓢ II 2 GD
 IP66 - IK09/10

NBR IEC:
Zone 1 and 2 - 21 and 22
 Ex de IIC Gb
 Inmetro (Portaria nº 179)
 IP66

Applications

- Plugs and receptacles are used with portable or stationery electrical equipment such as:
 - Lighting systems
 - Conveyors
 - Heaters
 - Motor generators
 - Air conditioning equipment
 - Compressors
 - Pumps
- For use in corrosive atmospheres and installations in Zone 1 and 2 and 21 and 22 of the oil and gas industry; such as:
 - Refineries
 - Chemical and petrochemical plants
 - Pipelines
 - Loading docks
 - Onshore and offshore drilling platforms

Features

- Plug and socket system is designed with a safe disconnect mechanism to insure maximum hazardous location protection:
 - The contact separation is in a flameproof chamber
 - The automatic electrical disconnection of each phase is contained in a second flameproof chamber
- Short circuit protection is 20 kA, while normal reference is 10 kA.
- Different voltages are color coded for easy identification.
- The receptacles are keyed to accept only ATX plugs (other plugs can not be inserted).
- ATX plugs can be used in non-hazardous IEC 309 sockets.
- Operating temperature of -40 °C to +55 °C (-40 °F to +131 °F)

Standard Materials

- Wall Socket for 2P - 2P+E - 3P: high impact resistance polycarbonate
- Wall Socket for 3P+E - 3P+N+E: high impact resistance fiberglass reinforced polyester
- Plug, mobile socket and flush socket: polyamide

ATEX/IECEX Certifications and Compliances

- Certification Type PCX, PCX/EN
- Gas: Zones 1 and 2
 - Conforming to ATEX 94/9/CE: CE 0081 Ⓢ II 2 G
 - ATEX/IEC Protection: Ex de IIC
 - T6 for $T_a \leq +40\text{ °C}$ (+104 °F) and T5 for $T_a \leq +55\text{ °C}$ (+131 °F)
 - Ambient Temperature: $-40\text{ °C} \leq T_a \leq +55\text{ °C}$ (-40 °F $\leq T_a \leq +131\text{ °F}$)
- Dust: Zones 21 and 22
 - Conforming to ATEX 94/9/CE: CE 0081 Ⓢ II 2 D
 - ATEX/IEC Protection: Ex tD A21
 - Surface Temperature: T68 °C (T154 °F)
 - Ambient Temperature: $-40\text{ °C} \leq T_a \leq +55\text{ °C}$ (-40 °F $\leq T_a \leq +131\text{ °F}$)
- CE Declaration of Conformity: 50228, 5C214
- ATEX Certificate: LCIE 02 ATEX 6068, LCIE 02 ATEX 0001U
- IECEX Certificate: IECEX LCI 04.0014, IECEX LCI 04.0012
- Other Certifications: GOST
- Ingress Protection (solid and liquid): IP66
- Impact Resistance (shock): IK10 (Polyester) and IK09 (Polyamide)
- Ex Standards: EN/IEC 60079-0; 60079-1; 60079-7; 61241-0; 61241-1
- Product Standards: EN/IEC 60309-1, 60309-2
- Other Standards: EN/IEC 60529 (IP), 62262 (IK)

**Plug****Wall Mounting Socket****Mobile Socket****Flush Socket****Technical Data**

Breaking Capacity	
AC 3	4 kW – 220 V
	4.3 kW – 240 V
	7.5 kW – 380 V
	8.2 kW – 415 V
ICC	20 kA

NBR IEC Brazilian Certifications and Compliances

- Certification Type PCX, PCX/EN
- Gas: Zones 1 and 2
- Dust: Zones 21 and 22
- IEC Protection: Ex de IIC Gb; T6 for $T_a \leq +40\text{ °C}$ (+104 °F) and T5 for $T_a \leq +55\text{ °C}$ (+131 °F)
- Ambient Temperature: $-40\text{ °C} \leq T_a \leq +55\text{ °C}$ (-40 °F $\leq T_a \leq +131\text{ °F}$)
- Inmetro Certificate: BR230639, BR230598-U
- Ingress Protection (solid and liquid): IP66
- Ex Standards: NBR IEC 60079-0; 60079-1; 60079-7
- Other Standards: NBR IEC 60529 (IP)

A.T.X.[®] PRE Series 16 Amp Plugs and Sockets

Increased Safety

ATEX/IECEX:
Zone 1 and 2 - 21 and 22
 II 2 GD
 IP66 - IK09/10

NBR IEC:
Zone 1 and 2 - 21 and 22
 Ex de IIC Gb
 Inmetro (Portaria n° 179)
 IP66



Wall Mounting Socket

- Three M20 threaded entries (one on the top and two on the bottom).
- Supplied with one M20 cable gland – Ø 6.5 to Ø 14.5 mm (Ø 0.26 to Ø 0.57") and two M20 blanking plugs.
- Terminal capacity 2 x 4 mm² (0.003 x 0.006 in²). Can be through-wired.
- Fitted with three linked earth terminals.



Plug

- One PG16 integrated cable gland – Ø 6.5 to Ø 14.5 mm (Ø 0.26 to Ø 0.57").
- Terminal capacity 2.5 mm² (0.004 in²).



Mobile Socket

- One PG16 integrated cable gland – Ø 6.5 to Ø 14.5 mm (Ø 0.26 to Ø 0.57").
- Terminal capacity 2 x 4 mm² (0.003 x 0.006 in²).



Flush Socket

- Terminal capacity 2 x 4 mm² (0.003 x 0.006 in²).

Catalog Numbering Guide - IECEX Internationally Certified Plugs and Receptacles

PRE
 IECEX Series:
 PRE - PRE Series
 Zone 1, 2, 21 and 22
 ATEX / IEC

2
 Pin Configuration:
 2 - 2P
 3 - 2P+E
 4 - 3P+E
 5 - 3P+N+E
 6 - 3P

16
 Amps:
 16 - 16A

R
 Equipment:
 P - Plug
 R - Receptacle
 (Wall Mounting)
 M - Mobile Socket
 F - Flush Socket

P
 Voltage:
 P - 20 - 25 Vac 50/60 Hz
 W1 - 20 - 50 Vdc
 W - 40 - 50 Vac 50/60 Hz
 Y - 100 - 130 Vac 50/60 Hz
 B - 200 - 250 Vac 50/60 Hz
 R - 380 - 415 Vac 50/60 Hz
 N - 480 - 500 Vac 50/60 Hz
 G - 50 - 500 Vac 300 to 500 Hz

Catalog Numbering Guide - NBR IEC Brazilian Certified Plugs and Receptacles

N PRE
 NBR IEC Series:
 PRE - PRE Series
 Zone 1, 2, 21 and 22
 NBR IEC Certified

2
 Pin Configuration:
 2 - 2P
 3 - 2P+E
 4 - 3P+E
 5 - 3P+N+E
 6 - 3P

16
 Amps:
 16 - 16A

R
 Equipment:
 P - Plug
 R - Receptacle
 (Wall Mounting)
 M - Mobile Socket
 F - Flush Socket

P
 Voltage:
 P - 20 - 25 Vac 50/60 Hz
 W1 - 20 - 50 Vdc
 W - 40 - 50 Vac 50/60 Hz
 Y - 100 - 130 Vac 50/60 Hz
 B - 200 - 250 Vac 50/60 Hz
 R - 380 - 415 Vac 50/60 Hz
 N - 480 - 500 Vac 50/60 Hz
 G - 50 - 500 Vac 300 to 500 Hz

ELV: Extra Low Voltage

Purple	White	White
20/25 Vac	20/50 Vdc	40/50 Vac







LV: Low Voltage

Yellow	Blue	Red	Black	Green
100/130 Vac	200/250 Vac	380/415 Vac	480/500 Vac	50/500 Vac (300 to 500 Hz)

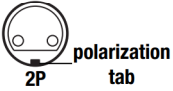
A.T.X.[®] PRE Series 16 Amp Extra Low Voltage and Low Voltage Plugs and Sockets**Increased Safety**

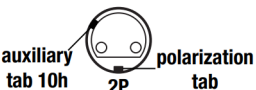
ATEX/IECEX:
Zone 1 and 2 - 21 and 22
II 2 GD
IP66 - IK09/10

NBR IEC:
Zone 1 and 2 - 21 and 22
Ex de IIC Gb
Inmetro (Portaria n° 179)
IP66

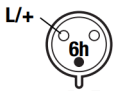
Description	Pin Configuration	Weight kg (lb)	Volume dm ³ (in ³)	Catalog Number	
				IECEX	NBR
Extra Low Voltage: ELV					
20/25 Vac 50/60 Hz – Purple					
Wall Socket		0.6 (1.3)	3.8 (231.89)	PRE216RP	NPRE216RP
Plug		0.2 (0.4)	0.6 (361.6)	PRE216PP	NPRE216PP
Mobile Socket		0.4 (0.9)	1.3 (79.33)	PRE216MP	NPRE216MP
Flush Socket		0.2 (0.4)	1.3 (79.33)	PRE216FP	NPRE216FP
Wall Socket		0.6 (1.3)	3.8 (231.89)	PRE316RP	NPRE316RP
Plug		0.2 (0.4)	0.6 (36.61)	PRE316PP	NPRE316PP
Mobile Socket		0.4 (0.9)	1.3 (79.33)	PRE316MP	NPRE316MP
Flush Socket		0.2 (0.4)	1.3 (79.33)	PRE316FP	NPRE316FP
Wall Socket		0.6 (1.3)	3.8 (231.89)	PRE616RP	NPRE616RP
Plug		0.2 (0.4)	0.6 (36.61)	PRE616PP	NPRE616PP
Mobile Socket		0.4 (0.9)	1.3 (79.33)	PRE616MP	NPRE616MP
Flush Socket		0.2 (0.4)	1.3 (79.33)	PRE616FP	NPRE616FP
20/50 Vdc – White					
Wall Socket		0.6 (1.3)	3.8 (231.89)	PRE216RW1	NPRE216RW1
Plug		0.2 (0.4)	0.6 (36.61)	PRE216PW1	NPRE216PW1
Mobile Socket		0.4 (0.9)	1.3 (79.33)	PRE216MW1	NPRE216MW1
Flush Socket		0.2 (0.4)	1.3 (79.33)	PRE216FW1	NPRE216FW1
40/50 Vac 50/60 Hz – White					
Wall Socket		0.6 (1.3)	3.8 (231.89)	PRE216RW	NPRE216RW
Plug		0.2 (0.4)	0.6 (36.61)	PRE216PW	NPRE216PW
Mobile Socket		0.4 (0.9)	1.3 (79.33)	PRE216MW	NPRE216MW
Flush Socket		0.2 (0.4)	1.3 (79.33)	PRE216FW	NPRE216FW
Wall Socket		0.6 (1.3)	3.8 (231.89)	PRE616RW	NPRE616RW
Plug		0.2 (0.4)	0.6 (36.61)	PRE616PW	NPRE616PW
Mobile Socket		0.4 (0.9)	1.3 (79.33)	PRE616MW	NPRE616MW
Flush Socket		0.2 (0.4)	1.3 (79.33)	PRE616FW	NPRE616FW
Low Voltage: LV					
100/130 Vac 50/60 Hz – Yellow					
Wall Socket		0.6 (1.3)	3.8 (231.89)	PRE316RY	NPRE316RY
Plug		0.2 (0.4)	0.6 (36.61)	PRE316PY	NPRE316PY
Mobile Socket		0.4 (0.9)	1.3 (79.33)	PRE316MY	NPRE316MY
Flush Socket		0.2 (0.4)	1.3 (79.33)	PRE316FY	NPRE316FY
200/250 Vac 50/60 Hz – Blue					
Wall Socket		0.6 (1.3)	3.8 (231.89)	PRE316RB	NPRE316RB
Plug		0.2 (0.4)	0.6 (36.61)	PRE316PB	NPRE316PB
Mobile Socket		0.4 (0.9)	1.3 (79.33)	PRE316MB	NPRE316MB
Flush Socket		0.2 (0.4)	1.3 (79.33)	PRE316FB	NPRE316FB

1300

Visit our website at www.appletonelec.com or contact us at (800) 621-1506.



© April 2015

A.T.X.[®] PRE Series 16 Amp Low Voltage Plugs and Sockets and Accessories

Increased Safety

ATEX/IECEX:
Zone 1 and 2 - 21 and 22
II 2 GD
IP66 - IK09/10

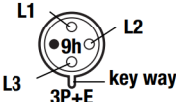
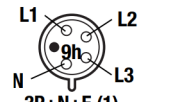
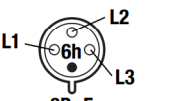
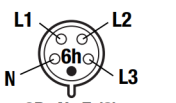
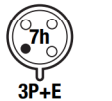
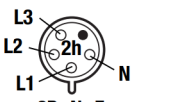
NBR IEC:
Zone 1 and 2 - 21 and 22
Ex de IIC Gb
Inmetro (Portaria n° 179)
IP66

Description	Pin Configuration	Weight kg (lb)	Volume dm ³ (in ³)	Catalog Number	
				IECEX	NBR
Low Voltage: LV					
200/250 Vac 50/60 Hz — Blue					
Wall Socket		1.5 (3.3)	4.7 (286.81)	PRE416RB	NPRE416RB
Plug		0.6 (1.3)	0.6 (361.6)	PRE416PB	NPRE416PB
Mobile Socket		0.6 (1.3)	4.0 (244.09)	PRE416MB	NPRE416MB
Flush Socket		0.2 (0.4)	1.3 (79.33)	PRE416FB	NPRE416FB
Wall Socket		1.6 (3.5)	4.7 (286.81)	PRE516RB	NPRE516RB
Plug		0.3 (0.7)	1.3 (79.33)	PRE516PB	NPRE516PB
Mobile Socket		0.6 (1.3)	4.0 (244.09)	PRE516MB	NPRE516MB
Flush Socket		0.2 (0.4)	1.3 (79.33)	PRE516FB	NPRE516FB
<i>(1) 120/208 V - 144/250 Vac 50/60 Hz</i>					
380/415 Vac 50/60 Hz — Red					
Wall Socket		1.5 (3.3)	4.7 (286.81)	PRE416RR	NPRE416RR
Plug		0.2 (0.4)	0.6 (361.6)	PRE416PR	NPRE416PR
Mobile Socket		0.6 (1.3)	4.0 (244.09)	PRE416MR	NPRE416MR
Flush Socket		0.3 (0.7)	1.3 (79.33)	PRE416FR	NPRE416FR
Wall Socket		1.6 (3.5)	4.7 (286.81)	PRE516RR	NPRE516RR
Plug		0.3 (0.7)	1.3 (79.33)	PRE516PR	NPRE516PR
Mobile Socket		0.6 (1.3)	4.0 (244.09)	PRE516MR	NPRE516MR
Flush Socket		0.3 (0.7)	1.3 (79.33)	PRE516FR	NPRE516FR
<i>(2) 200/346 V - 240/415 Vac 50/60 Hz</i>					
480/500 Vac 50/60 Hz — Black					
Wall Socket		1.5 (3.3)	4.7 (286.81)	PRE416RN	NPRE416RN
Plug		0.2 (0.4)	0.6 (361.6)	PRE416PN	NPRE416PN
Mobile Socket		0.6 (1.3)	4.0 (244.09)	PRE416MN	NPRE416MN
Flush Socket		0.3 (0.7)	1.3 (79.33)	PRE416FN	NPRE416FN
50/500 Vac 300/500 Hz — Green					
Wall Socket		1.6 (3.5)	4.7 (286.81)	PRE516RG	NPRE516RG
Plug		0.2 (0.4)	0.6 (361.6)	PRE516PG	NPRE516PG
Mobile Socket		0.6 (1.3)	4.0 (244.09)	PRE516MG	NPRE516MG
Flush Socket		0.3 (0.7)	1.3 (79.33)	PRE516FG	NPRE516FG
Accessories					
		M5 earth stud with black neoprene sealing washer and green/yellow earth conductor, length 300 mm (11.8")		PREESTM20	NPREESTM20
		M20 earth continuity adaptor with black neoprene sealing washer and green/yellow earth conductor, length 300 mm (11.8")		PREECAM20	NPREECAM20

A.T.X.[®] PRE Series 16 Amp Plug and Socket Dimensions

Increased Safety

Dimensions

16A – 2P – 2P+E – 3P Versions

Wall Mounting Sockets

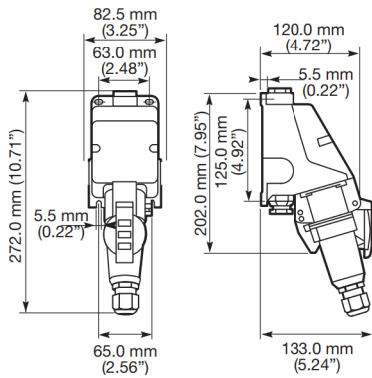

Plugs

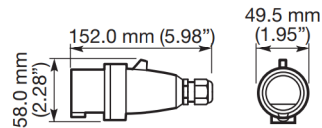

Mobile Sockets

Can be mounted on panel - 0.12"/3.0 mm thickness maximum

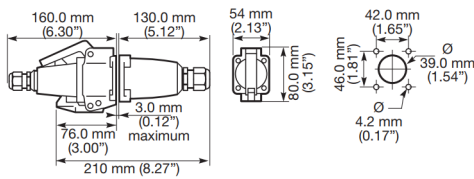

Flush Sockets

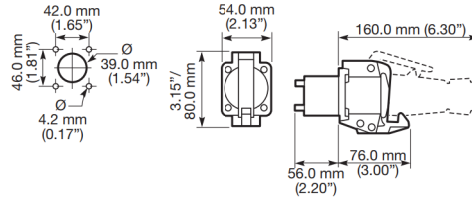

16A – 3P+E – 3P+N+E Versions

Wall Mounting Sockets

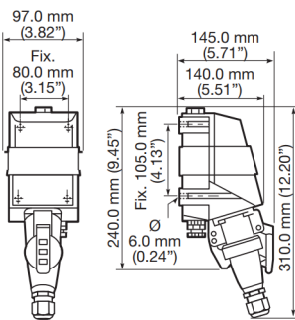

Plugs

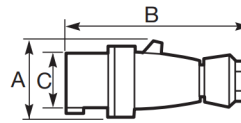

Dimensions in Millimeters (Inches)			
	A	B	C
3 P + E	66.0 (2.60)	154.0 (6.06)	55.5 (2.19)
3 P + N + E	73.0 (2.87)	166.0 (6.54)	62.0 (2.44)

Mobile Sockets

Can be mounted on panel - 3.0 mm (0.12") thickness maximum

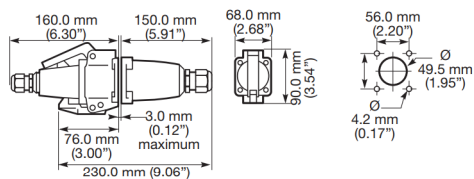

Flush Sockets

